

# PRONTA CONSEGNA

USATE LE BUONE MANIGLIE

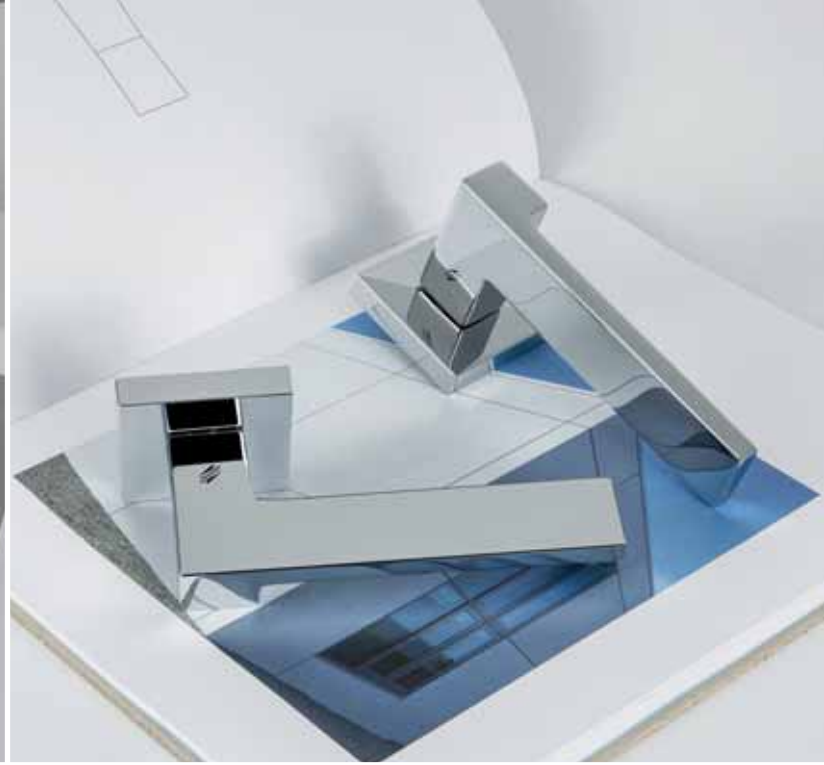

PREMIUM PARTNER



# Progettare e costruire in Italia le maniglie più belle al mondo.

Proprio come una famiglia accudisce i suoi membri con amore e dedizione, così Colombo Design cura i suoi prodotti, con gli stessi valori e le medesime tradizioni, per fare di ogni ambiente una casa, senza scendere mai a compromessi sull'autenticità. Un manifesto contemporaneo dell'essere creativi, curiosi e sperimentali.



Trattamento di protezione  
garantito **30 anni**  
(processo pvd)



**HPS**  
zirconium  
gold



**GM**  
grafite  
mat



Trattamento di protezione  
garantito **10 anni**



**OL**  
oroplus



**CR**  
cromo



**CM**  
cromat



**NM**  
neromat  
RAL 9005



**BI**  
biancomat  
RAL 9016



**mood**  
COLLECTION



**C01**  
white



**C02**  
bronze



**C03**  
black



**C04**  
silver



**C06**  
ocean blue



# ROBOQUATTRO

Design: Colombo Design

## 0ID41 R-RY Ø50

### MANIGLIA SU ROSETTA

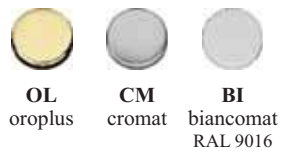
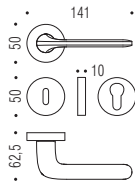

## 0ID41 RSMY

### MANIGLIA SU ROSETTA STRETTA

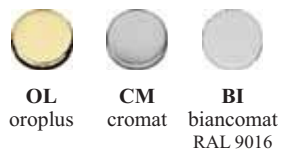
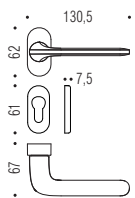

## 0ID42 DK/SM

### MANIGLIA DK

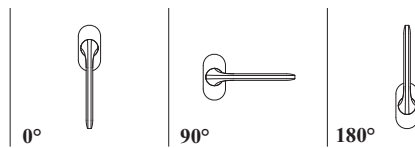
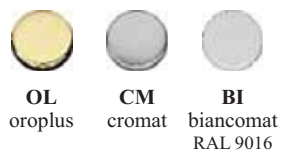
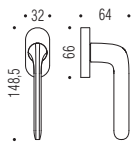

Robotech® contraddistingue una gamma di prodotti realizzata utilizzando alta tecnologia e massima automazione per ottenere eccellenza qualitativa e commerciale.



R FORTINET

RIC,  
VELO  
AUTO

### QUALE STRATEGIA DEVONO METTERE IN ATTO LE IMPRESE PER PROTEGGERSI AL MEGLIO?

L'evoluzione digitale richiede un nuovo approccio alla sicurezza. Serve un cambio di passo, che deve essere sposato sia dal management che dai dipendenti. Per riuscire a contrastare gli sforzi dei criminali informatici, le organizzazioni devono includere le strategie di sicurezza nei loro sforzi di digital transformation. Devono inserirla nei piani di sviluppo e di crescita e comprendere che non si tratta di un costo, ma di un investimento.

che nel cloud. Questo approccio di condividere una threat intelligence utilizzabile in modo rapido riduce le finestre di rilevamento e fornisce una risoluzione necessaria per gli exploit di oggi. Consente quindi più soluzioni per reagire all'unisono alla minaccia. Velocità, integrazione e automazione sono fondamentali per la difesa. Per questo Fortinet rivolge alle imprese di tutte le dimensioni, dalle piccole e medie imprese alla difesa, le differenze di investimento.

...zione e di scala. L'intelligence avanzata correlata e condivisa tra tutti gli elementi di sicurezza deve essere automatizzata per ridurre le finestre di rilevamento necessarie e fornire una soluzione rapida. L'integrazione dei singoli prodotti attraverso la rete distribuita, combinata alla segmentazione strategica, contribuirà in modo significativo a combattere la natura sempre più intelligente e automatizzata degli attacchi.

I dispositivi di sicurezza di legacy e isolati e una scarsa considerazione della sicurezza continuano a rappresentare un pericolo e aumentano il rischio nel panorama delle minacce odierne, poiché non forniscono visibilità o controllo adeguati. Invece, un "security fabric", un tessuto di sicurezza integrato tra ogni elemento, è vitale per comprendere il panorama odierno e rispondere in continua crescita e per prevenire il rischio di attacco in

### IN QUESTO MONDO SEMPRE PIÙ DIGITALE (SOFTWARE, CLOUD, RETI) LE IMPRESE DEVONO INTEGRARE LA SICUREZZA

### COS'È IL SECURITY FABRIC?

È l'approccio di Fortinet al tema della cyber security, è l'insieme di soluzioni per rispondere alle minacce come se fossero un unico organismo. Una piattaforma organicamente integrata da zero, che offre un ampio set di funzionalità di sicurezza con automazione eccezionali, e l'implementazione in modo

...ni botnet continuano a colpire le organizzazioni. Lo confermano le analisi dei ricercatori del team FortiGuard Labs nel loro ultimo Global Threat Landscape report. Gli attacchi informatici crescono e la loro organizzazione è fondamentale per

avversari continuano a incorporare nuove minacce e a sfruttare tecniche sempre più automatizzate in termini di velocità e scalabilità per le loro attività dannose, segmentazione e integrazione diventano elementi critici di sicurezza strategica per gli ambienti IT e OT odierni. Non esiste una strategia di difesa futura che includa l'automazione o il machine learning senza un mezzo per raccogliere, analizzare e rispondere alle informazioni sulle minacce per produrre





# ROBOCINQUE S

Design: Colombo Design

## 0ID71 R-RY 52x52

### MANIGLIA SU ROSETTA

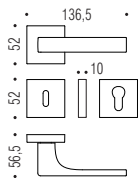

## 0ID71 RSMY

### MANIGLIA SU ROSETTA STRETTA

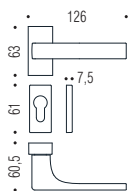

## 0ID72 DK/SM

### MANIGLIA DK

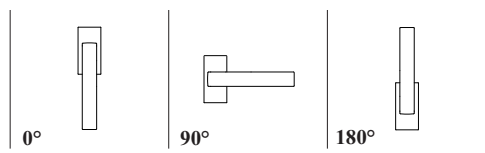
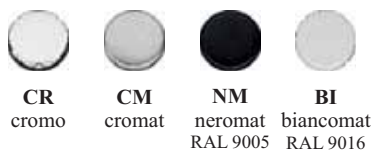
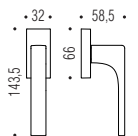

Robotech® contraddistingue una gamma di prodotti realizzata utilizzando alta tecnologia e massima automazione per ottenere eccellenza qualitativa e commerciale.



# Supporterà 9 ne pieghevoli

## È

ufficiale, lo ha annunciato Google: la so-  
dispositivi pieghevoli con il suo sist-  
in modo nativo il supporto a que-  
Gli ingegneri sono già all'opera  
Engineering di Android, ha sp-  
permettere agli sviluppatori, in fu-  
loro dispositivi che girano con And-  
Il sistema operativo del robotino ve-  
dispositivo che può essere pensato sia come  
definito dallo stesso vice presidente  
"In generale - spiega Burke - ci sono due varianti del  
singolo schermo. Una volta piegato, sembra un telefono  
in borsa. La caratteristica che definisce questo fattore di  
chiamiamo continuità".

Con questa spiegazione, Burke non solo accenna alla cara-  
sarà donato Android, che dalla "versione smartphone" pa-  
Per il momento, infatti, l'unico grande produttore che  
fa riferimento al prossimo anno e che presenta due  
pieghevole è stato Samsung, quello del dispositivo c-

Per il momento, infatti, l'unico grande produttore che  
fa riferimento al prossimo anno e che presenta due  
pieghevole è stato Samsung, quello del dispositivo c-

Per il momento, infatti, l'unico grande produttore che  
fa riferimento al prossimo anno e che presenta due  
pieghevole è stato Samsung, quello del dispositivo c-

Per il momento, infatti, l'unico grande produttore che  
fa riferimento al prossimo anno e che presenta due  
pieghevole è stato Samsung, quello del dispositivo c-

Per il momento, infatti, l'unico grande produttore che  
fa riferimento al prossimo anno e che presenta due  
pieghevole è stato Samsung, quello del dispositivo c-





# DKZERO

MINIMAL SOLUTION

Nasce DK ZERO.  
Un innovativo sistema per finestra quasi ad "impatto zero", che consente di ridurre al minimo l'ingombro della rosetta DK. DK ZERO è di semplice installazione (è sufficiente un foro di diametro 20mm), adatto all'utilizzo su infissi dotati di microventilazione e adattabile a molteplici modelli e finiture della collezione Colombo Design.

## 0ID42 DK0/SM

### MANIGLIA DKZERO - ROBOQUATTRO

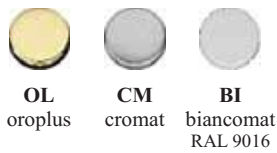
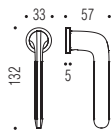

## 0ID72 DK0/SM

### MANIGLIA DKZERO - ROBOCINQUE S

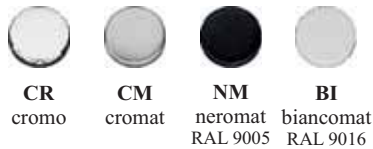
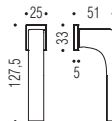

### UNI EN 13126-3

Certificazione di durabilità garantita per minimo 25.000 cicli, ciascuno con sequenza: 0 - 90° - 180° - 90° - 0°









**MM13 BS**

BOCCHETTA STRETTA

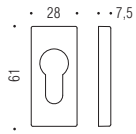

**CR**  
cromo



**CM**  
cromat



**GM**  
grafite mat



**0CD63 GB (Y) Ø70**

BOCCHETTA

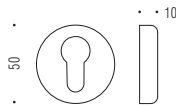

**OL**  
oroplus



**CM**  
cromat



**XDK 30  
XDK 35  
XDK 40**

MOVIMENTO DK

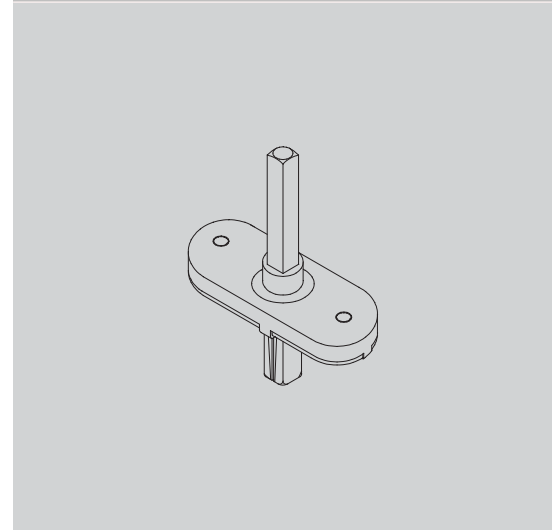
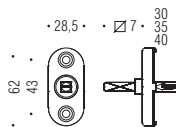

**XDK ZERO 30  
XDK ZERO 35  
XDK ZERO 40**

MOVIMENTO DK/ZERO

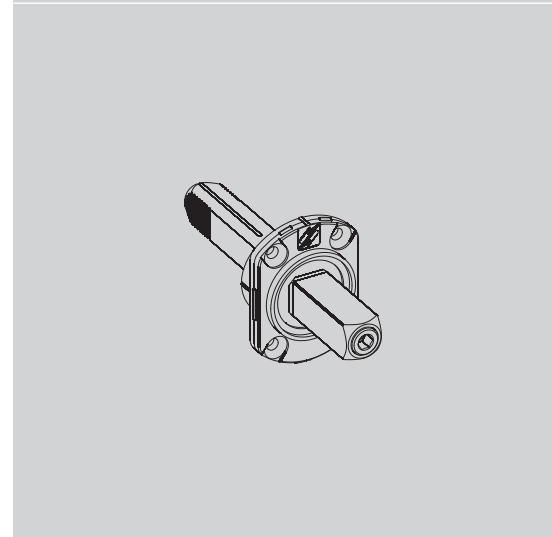
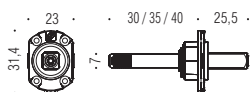

# PUSH

Design: Luca Colombo

## 0LC55 FISSO

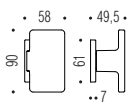

## POMOLO FISSO



CR  
cromo



CM  
cromat



NM  
neromat  
RAL 9005



# ROBOT

Design: Colombo Design

## 0CD55 FISSO Ø70



## POMOLO FISSO



OL  
oroplus



CM  
cromat



# ELLE

Design: Team3

**0ID36**

MANIGLIONE SENZA ROSETTE

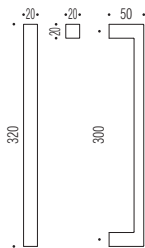

**CR**  
cromo



**CM**  
cromat



**NM**  
neromat  
RAL 9005



**BI**  
biancomat  
RAL 9016

# FIVE

Design: Colombo Design

**0ID56**

MANIGLIONE SENZA ROSETTE

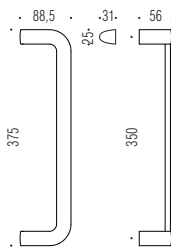

**CR**  
cromo



**CM**  
cromat



**NM**  
neromat  
RAL 9005



**BI**  
biancomat  
RAL 9016

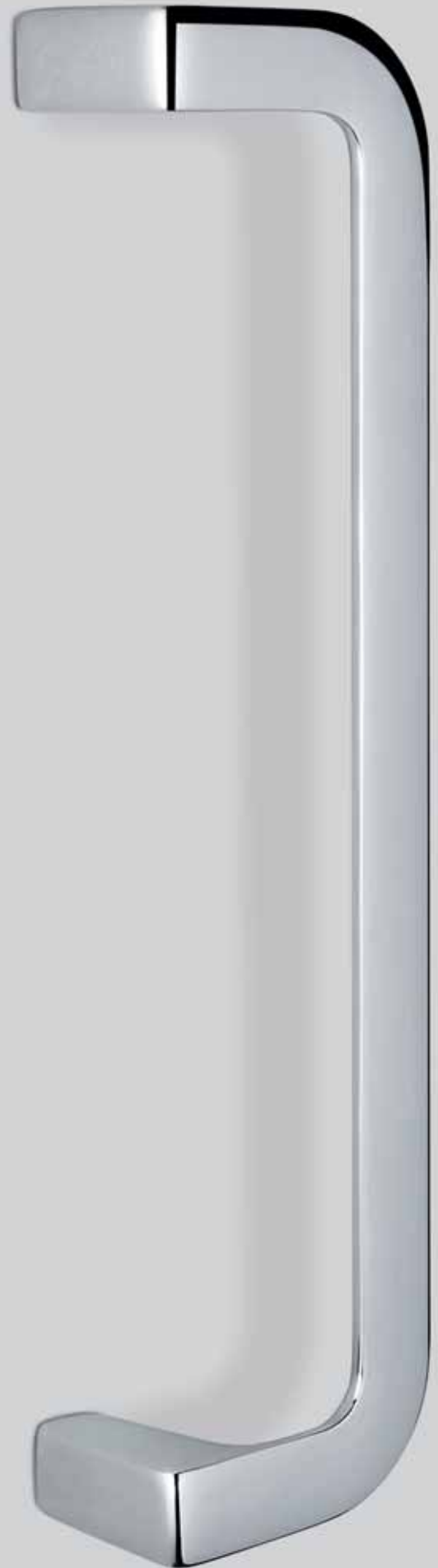

# FLESSO

Design: Carlo Bartoli

## 0CB16 Z/A

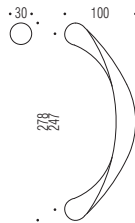

## 0CB16 Z/B

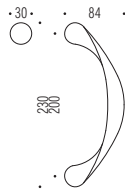

## MANIGLIONE SENZA ROSETTE



**OL**  
oroplus

**CM**  
cromat

**NM**  
neromat  
RAL 9005

# LOGO

Design: Colombo Design

## 0LC16 L

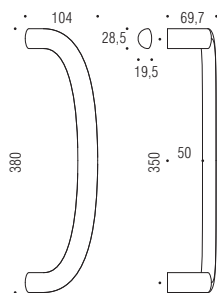

## MANIGLIONE SENZA ROSETTE



**OL**  
oroplus

**CM**  
cromat

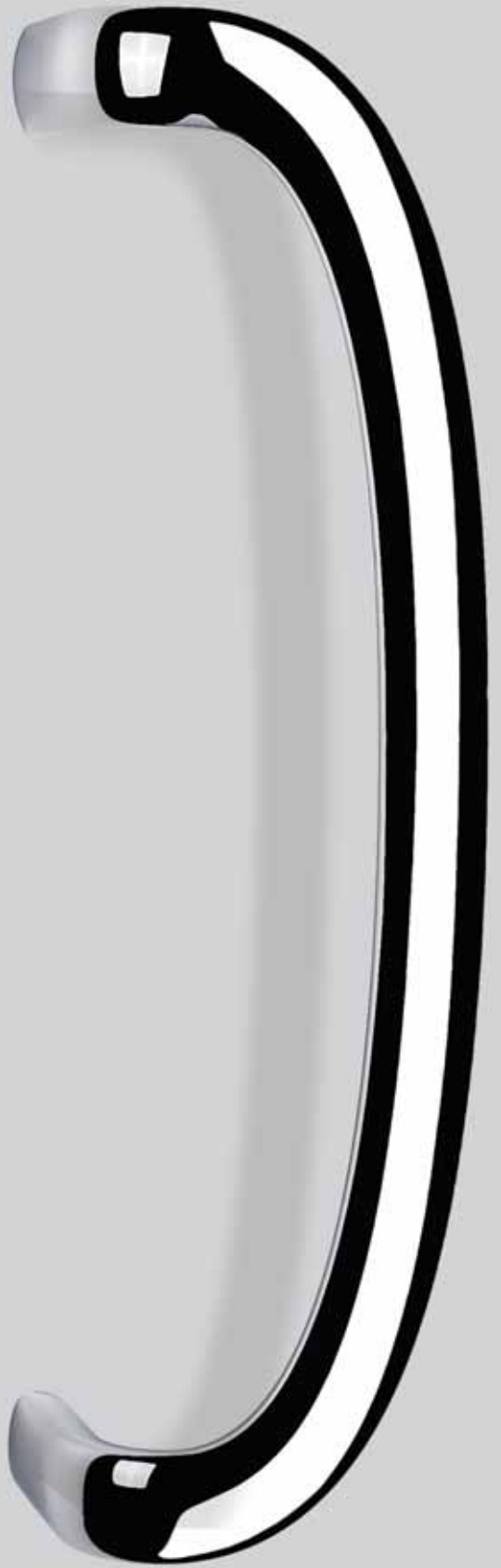

# ID313

Design: Colombo Design

**0ID313**

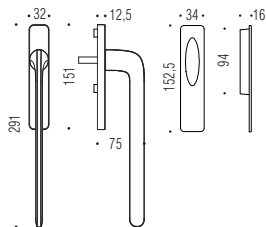

**0ID413 Y**

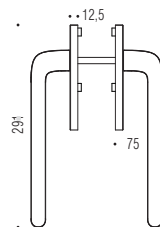

MANIGLIONE PER ALZANTE COMPLANARE

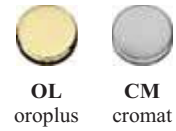

# ID513

Design: Colombo Design

**0ID513**

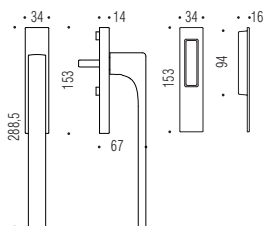

**0ID613 Y**

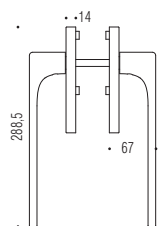

MANIGLIONE PER ALZANTE COMPLANARE

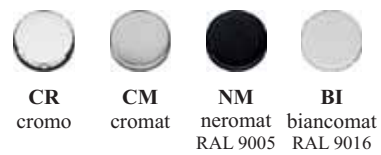



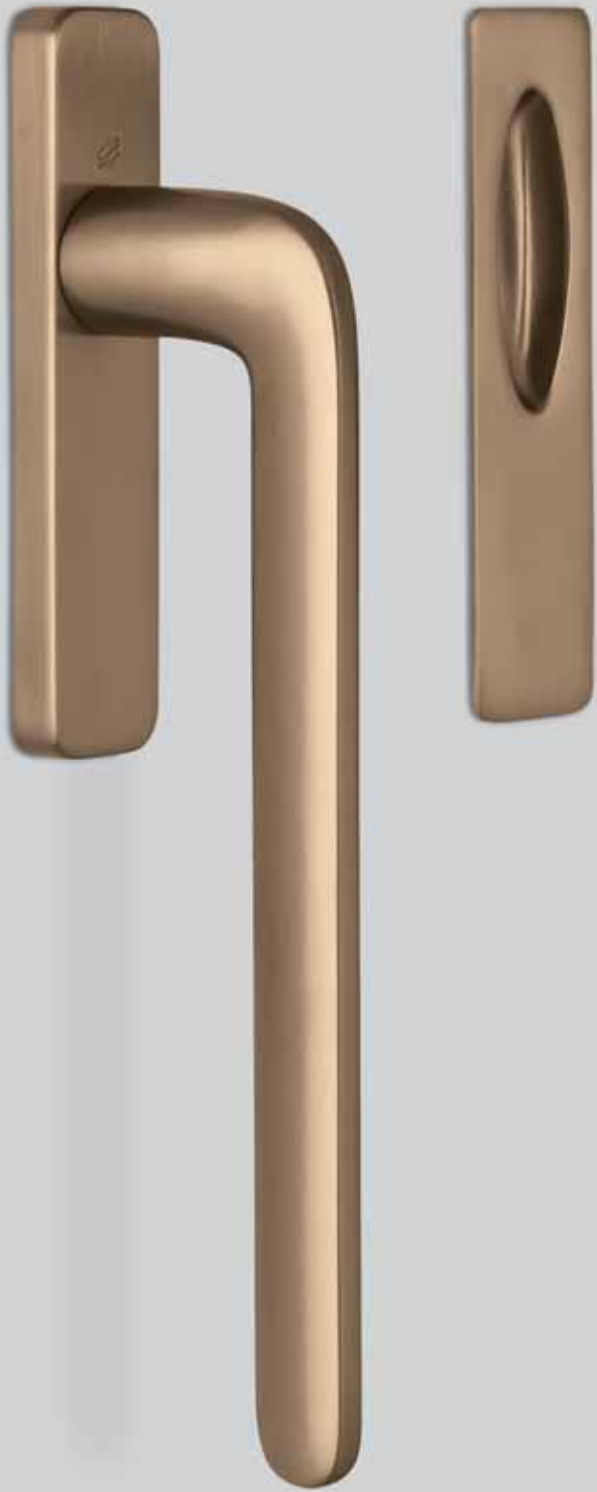

# OPEN

Design: Team3

## 0ID211

MANIGLIA AD INCASSO

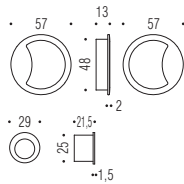

## 0ID211 LK

MANIGLIA AD INCASSO CON SERRATURA

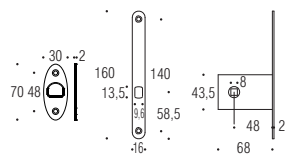
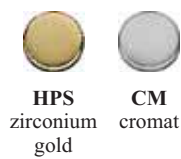
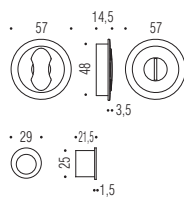

# OPEN SQ

Design: Team3

## 0ID311

MANIGLIA AD INCASSO

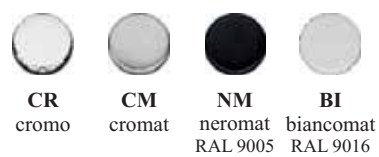
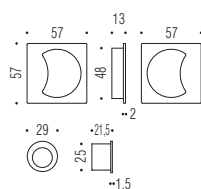

## 0ID311 LK

MANIGLIA AD INCASSO CON SERRATURA

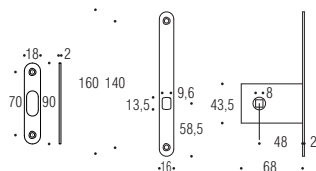
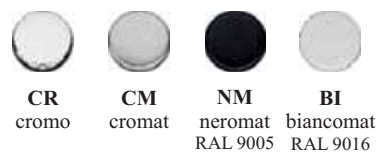
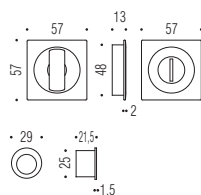



A disposizione una gamma di 12 colori, accuratamente selezionati per poter definire il *mood* di una stanza, così come lo stile di una porta o di un serramento attraverso accostamenti tono su tono o in abbinamento.

## OneQ

Design: Colombo Design

### 0CC21 R 52x52

MANIGLIA SU ROSETTA

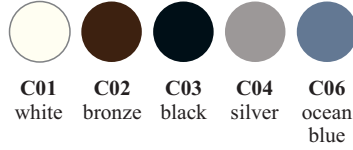
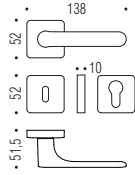

### 0CC21 RSMY

MANIGLIA SU ROSETTA STRETTA

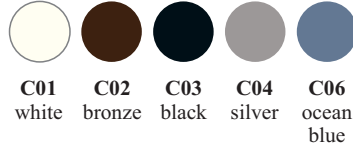
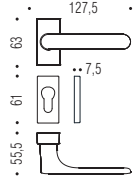

### 0CC22 DK/SM

MANIGLIA DK

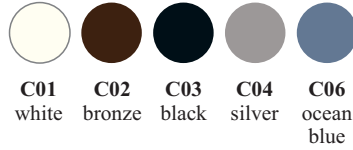
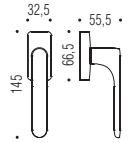

### 0CC311 BZG

MANIGLIA AD INCASSO

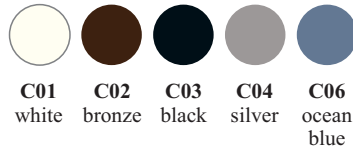
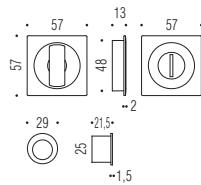

### 0CC113

MANIGLIONE PER ALZANTE SCORREVOLE

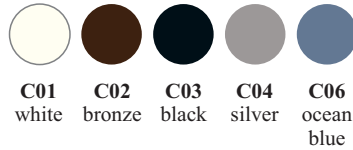
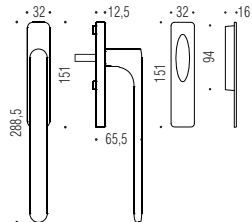

### 0CC213 Y

MANIGLIONE PER ALZANTE SCORREVOLE

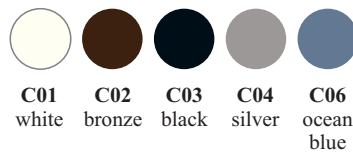
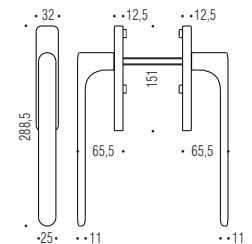



**Ne facciamo  
di tutti i colori.**





SISTEMI ESPOSITIVI

**BSP**

PANNELLO MONOFACCIALE

Nero

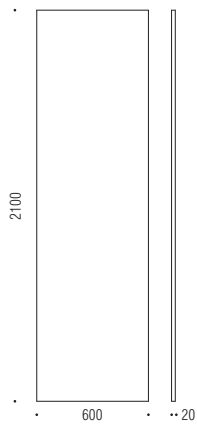

**T6**

PANNELLO MONOFACCIALE BISELLATO

Frassino con testata bianca

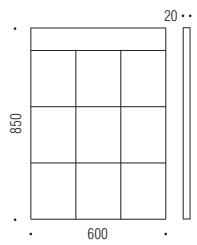



### DMOOD/BOARD

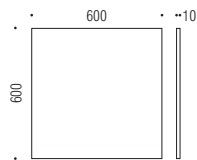

#### PANNELLO MONOFACCIALE

Sei pannelli espositivi in forex dotati di ganci per installazione a muro. Ogni MOOD BOARD presenta due maniglie ("One" e "OneQ") proposte in due dei dodici colori a catalogo, attraverso la loro installazione all'interno di un composit fotografico realizzato con immagini di ambientazioni di interior design, elementi materici, naturali e architettonici.

### DMOOD/BOX

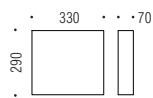

#### PANNELLO MONOFACCIALE

Scatola campione con apertura a libro e chiusura magnetica al cui interno sono inserite sei maniglie "One" e sei maniglie "OneQ". Dodici maniglie per dodici colori, per poterne apprezzare dal vivo qualità estetiche e tecniche.

### DMOOD/DISPL.

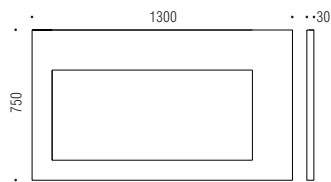

#### PANNELLO MONOFACCIALE

Pannello espositivo con dodici maniglie, proposte nei dodici colori a catalogo attraverso un percorso narrativo che ripercorre altrettante tappe significative della storia di Colombo Design dal 1990 al 2020. Ogni maniglia è installata su un pannello estraibile, al cui interno viene mostrato il racconto di ogni singola tappa aziendale. Predisposto per fissaggio a muro.





### ASSISTENZA

Assistenza tecnica e commerciale qualificata e sempre disponibile per offrire soluzioni rapide a qualsiasi richiesta post-vendita.



### DESIGN

Prodotti dal design unico creati in collaborazione con designers e studi di architettura di rilevanza internazionale.



### INNOVAZIONE

Innovazione di prodotto e di processo trovano espressione nella proposta di nuovi modelli, finiture e nel rinnovamento costante dei processi produttivi.



### MADE IN ITALY

Creatività, know-how, cura per il dettaglio, eccellenza manifatturiera e produzione sul territorio: Colombo Design è 100% Made in Italy.



### GARANZIA 30/10 ANNI

La selezione dei migliori materiali e l'applicazione di specifici trattamenti ad alta protezione assicurano ai prodotti prestazioni di lunga durata, con garanzia standard di 10 anni e 30 anni per i modelli con trattamento PVD.



### GREEN MADE

La riduzione dell'impatto ambientale ed il raggiungimento di obiettivi di eco compatibilità orientano ogni fase decisionale e produttiva all'interno dell'azienda, certificata UNI EN ISO 14001:2015



COLOMBODESIGN.IT



EDILSIDER S.p.A.  
Via Benedetto Croce, 26  
91011 Alcamo (TP)  
Tel. 0924.21588

DEPOSITO SICILIA ORIENTALE  
Contrada Pirritino Pantano  
Zona industriale Ovest  
Piano Tavola - Belpasso (CT)

mail: [servizioclienti@edilsiderspa.it](mailto:servizioclienti@edilsiderspa.it)  
website: [www.edilsiderspa.it](http://www.edilsiderspa.it)

